

ONKYO SERVICE MANUAL

Integrated Stereo Amplifier MODEL A-8087

UDN, UD	120V AC, 60Hz
UG	220V AC, 50Hz
UW	120V or 220V AC, 50/60Hz

SAFETY-RELATED COMPONENT WARNING!!

COMPONENTS IDENTIFIED BY MARK Δ ON THE SCHEMATIC DIAGRAM AND IN THE PARTS LIST ARE CRITICAL FOR RISK OF FIRE AND ELECTRIC SHOCK. REPLACE THESE COMPONENTS WITH ONKYO PARTS WHOSE PARTS NUMBERS APPEAR AS SHOWN IN THIS MANUAL.

MAKE LEAKAGE-CURRENT OR RESISTANCE MEASUREMENTS TO DETERMINE THAT EXPOSED PARTS ARE ACCEPTABLY INSULATED FROM THE SUPPLY CIRCUIT BEFORE RETURNING THE APPLIANCE TO THE CUSTOMER.

TABLE OF CONTENTS

Item	Page
Specifications	2
Block diagram	2
IC block diagram	3
Precautions	4
Main amplifier adjustment	4
Front panel facilities	5
System connections	5
Exploded view	6
Exploded view parts list	7
Printed circuit board parts list	8
Printed circuit board view	11
Schematic diagram	13, 17
Packing procedures	20

ONKYO
AUDIO COMPONENTS

SPECIFICATIONS

Power Output:	100 watts per channel, min. RMS, at 8 ohms, both channels driven, from 20Hz to 20kHz, with no more than 0.015% THD.
Total Harmonic Distortion:	0.015% at rated power
IM Distortion:	0.005% at rated power
Damping Factor:	50 at 8 ohms
Frequency Response:	2–50,000Hz ± 1dB
RIAA Deviation (MM):	2–20,000Hz ± 0.3dB
Sensitivity and Impedance:	Phone (MM): 2.5mV/50 kohms Phone (MC): 160μV/100/220 ohms Tuner: 150mV/50 kohms Tape Play: 150mV/50 kohms Tape Rec: 150mV/1.5 kohms (phono)
Preout:	1.0V/600 ohms
Phono Overload:	200mV RMS at 1kHz, 0.015% THD
Bass Control:	±8 dB at 70Hz
Treble Control:	±8 dB at 20,000Hz
Signal to Noise Ratio:	Phono (MM): 80dB (IHF A-202, 5mV input, 1 watt output) Phono (MC): 72dB (IHF A-202, 0.5mV input, 1 watt output) Tuner & Tape: 84dB (IHF A-202, 0.5V input, 1 watt output)
Muting:	–20dB
Loudness Control:	+6dB at 70Hz, +5dB at 20kHz
Subsonic Filter:	15Hz (6dB/Octave)
High Cut (TREBLE MIN):	6kHz (6dB/Octave)

General

Power Supply:	AC120V, 60Hz [D model] AC220V, 50Hz [G model] AC120V or 220V, 50/60Hz [W model]
Semiconductors:	IC: 5 TR: 42 Diode: 46
Dimensions:	435(W) x 144(H) x 396(D)mm 17 1/8" x 5 5/8" x 15 1/2"
With side panels:	467(W) x 146(H) x 396(D)mm 18 3/8" x 5 3/4" x 15 1/2"
Weight:	12.9kg. 28.4lbs.
With side panels:	14 kg. 30.9lbs.

Only USA models are equipped with wood grain side panels.

Specifications and features are subject to change without notice.

BLOCK DIAGRAM

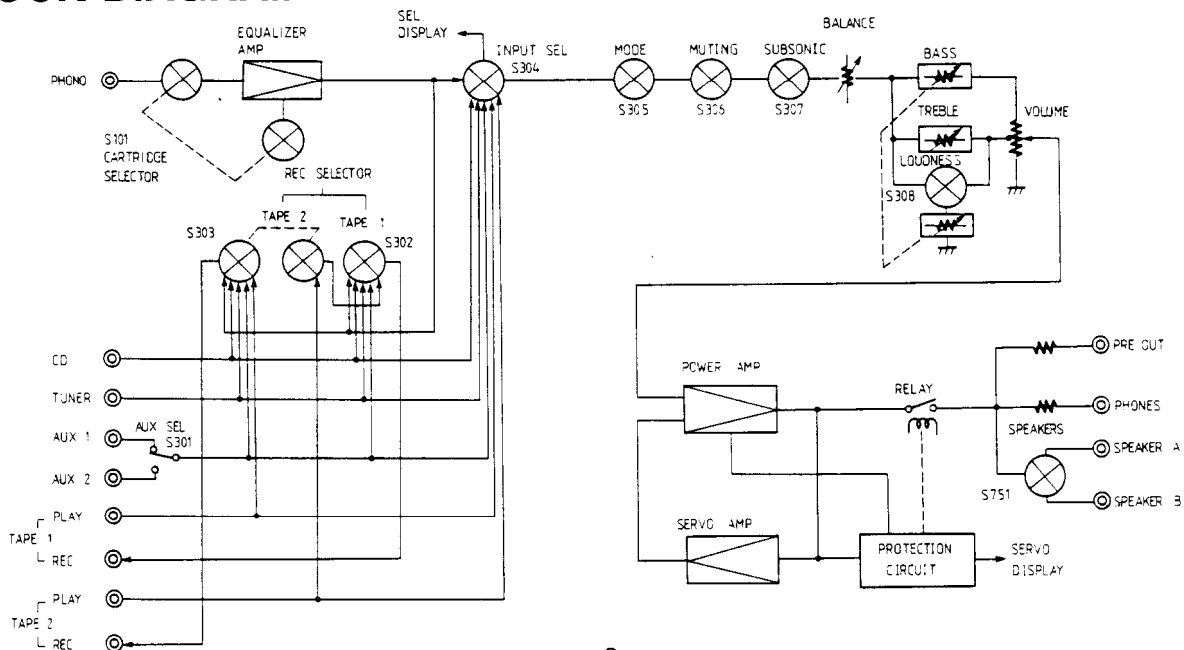

PRECAUTIONS

1. Replacing the fuses

For continued protection against risk fire, replace only with same type and same rating fuse.

CIRCUIT NO.	PARTS NO.	DESCRIPTION
F901	252052	7A (ST-6), Primary fuse (120V model, 120V/220V model)
F901	252077	4A-SE-EAK, Primary fuse (220V model)
F902	252077	4A-SE-EAK, Primary fuse (120V model)
F701	252070	1A-SE-EAK, Secondary fuse (220V model)

2. Replacing the lamp

This unit uses the lamp listed below.

CIRCUIT NO.	PARTS NO.	DESCRIPTION
PL701	210183	PL14V0.06AW-2.0

3. Insulation resistance measurement (Only U.S.A model)

Connect the insulating-resistance tester between the plug of power supply cable and the terminal GND on the back panel. Specifications; More than 10M Ω at 500V.

4. Voltage selector (rear panel)

Worldwide models are equipped with a voltage selector to conform with local power supplies. Be sure to set this switch to match the voltage of the power supply in your area before turning the power switch on. Voltage is changed by sliding the groove in the switch with a screwdriver or similar instrument to the up or down position. Confirm that the switch has been moved all the way to the up or down before turning the power switch on. If there is no voltage selector switch on the unit you have purchased, it can only be used in areas where the power supply voltage is the same as that of the unit.

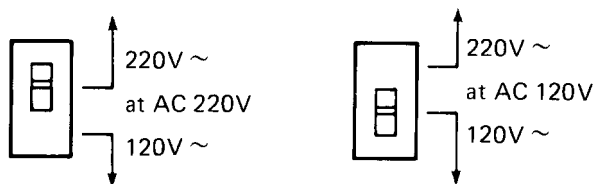

MAIN AMPLIFIER ADJUSTMENT

Set the all control knobs to standard position

Standard knob position

INPUT SELECTOR	CD
CARTRIDGE SELECTOR	MM
REC. SELECTOR	OFF
MODE	STEREO
MUTING	OFF
SUBSONIC FILTER	OFF
BALANCE	Center
VOLUME	Minimum
LOUDNESS	OFF
BASS	DEFEAT
TREBLE	DEFEAT
SPEAKERS	A

NOTES.

Adjust after switching on for 10 minutes.
 VOLUME Minimum
 LOAD Open

IDLING CURRENT ADJUSTMENT

1. Connect the DC voltmeter between I_{ID} and V_{CT} terminals.
2. Adjust the voltage to 15V \pm 5mV with semi-fixed resistor of R531 and R532.

SCHEMATIC DIAGRAM (120V Model, 120V/220V Model)

A B C D E F G H

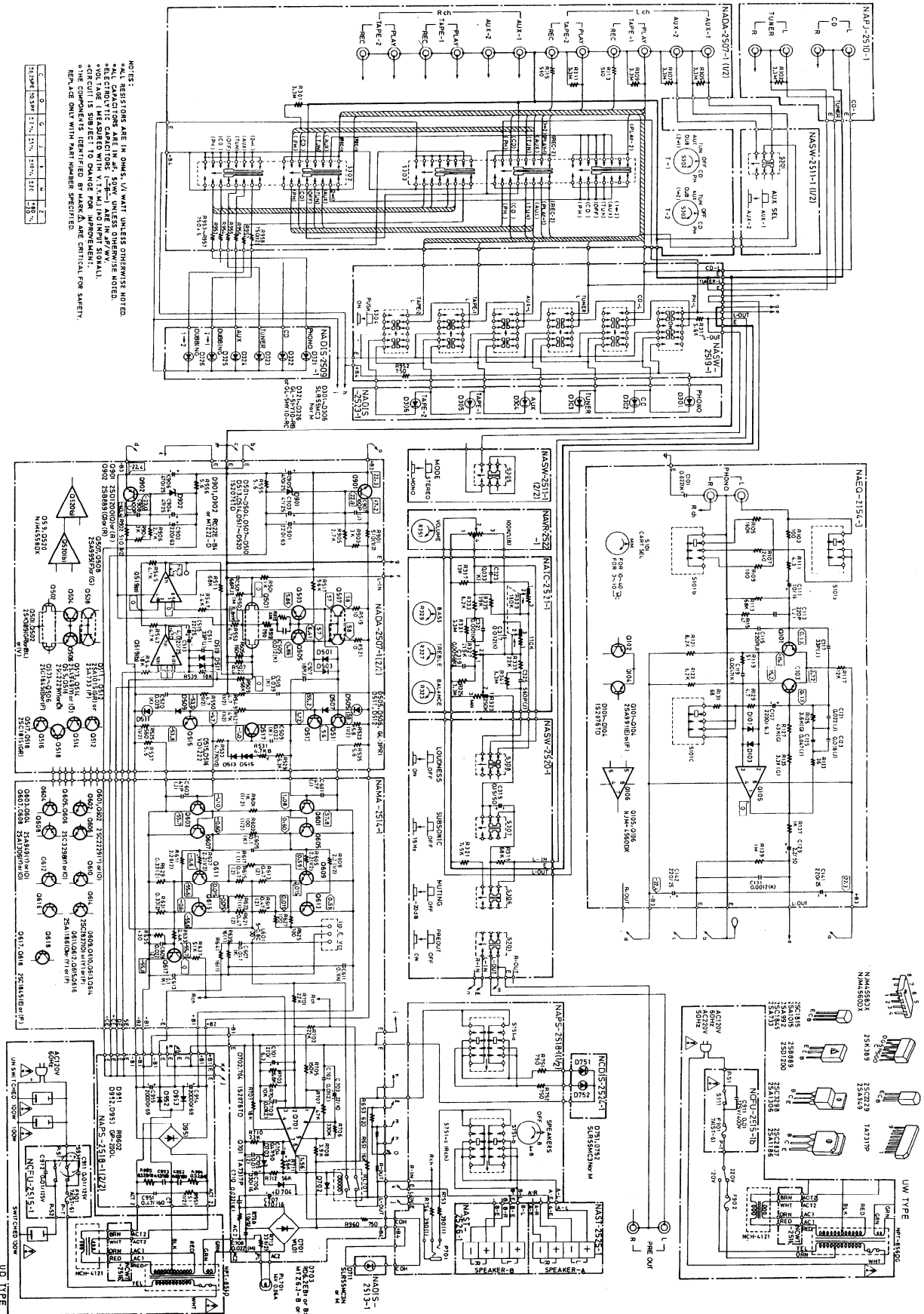

ONKYO CORPORATION

UD TYPE

FRONT PANEL FACILITIES

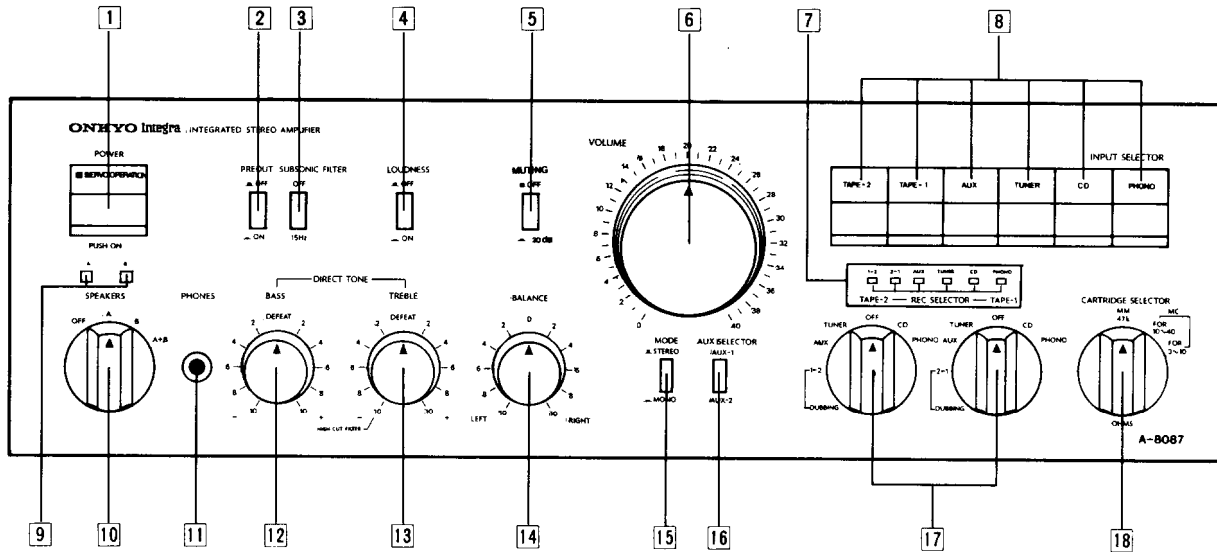

1. Power Switch (POWER)
2. Preout Switch (PREOUT)
3. Subsonic Filter (SUBSONIC FILTER)
4. Loudness Control (LOUDNESS)
5. Muting Switch (MUTING)
6. Volume Control (VOLUME)
7. Recording Mode Indicator
8. Input Selector Switches and Indicator (INPUT SELECTOR)
9. Sepaker Selector Indicators
10. Speaker Selector (SPEAKERS)
11. Headphone Jack (PHONES)
12. Bass Control (BASS)
13. Treble Control (TREBLE)
14. Balance Control (BALANCE)
15. Mode Selector (MODE)
16. AUX Selector Switch (AUX SELECTOR)
17. Recording Source Selectors (REC. SELECTOR)
18. Cartridge Selector (CARTRIDGE)

SYSTEM CONNECTIONS

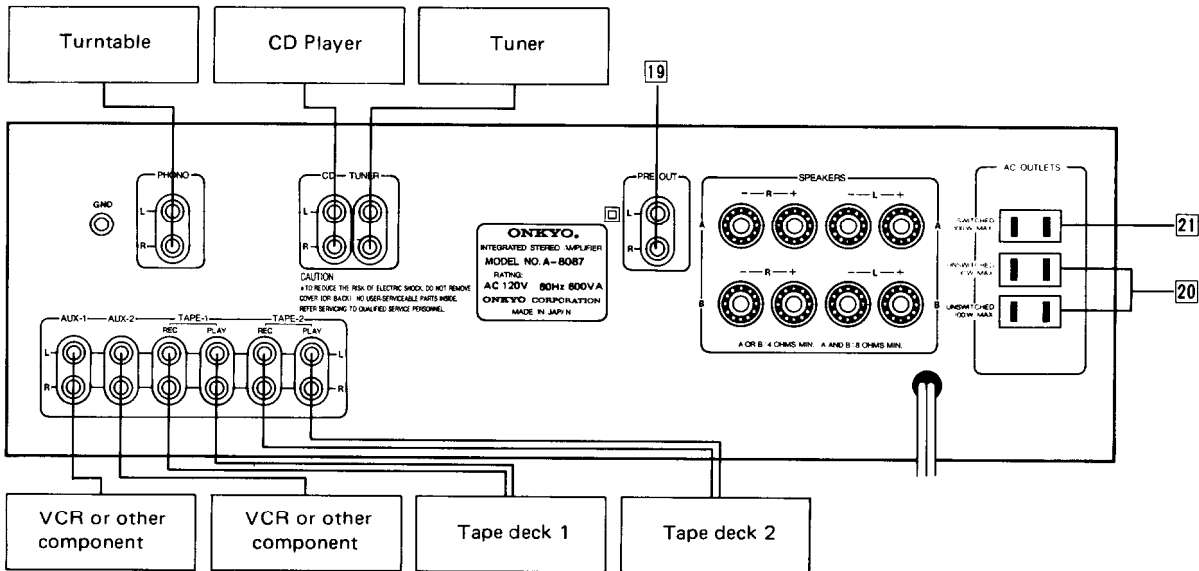

19. Preout
20. AC Outlets (UNSWITCHED) [Only 120V model]
21. AC Outlet (SWITCHED) [Only 120V model]

CHASSIS-EXPLODED VIEW

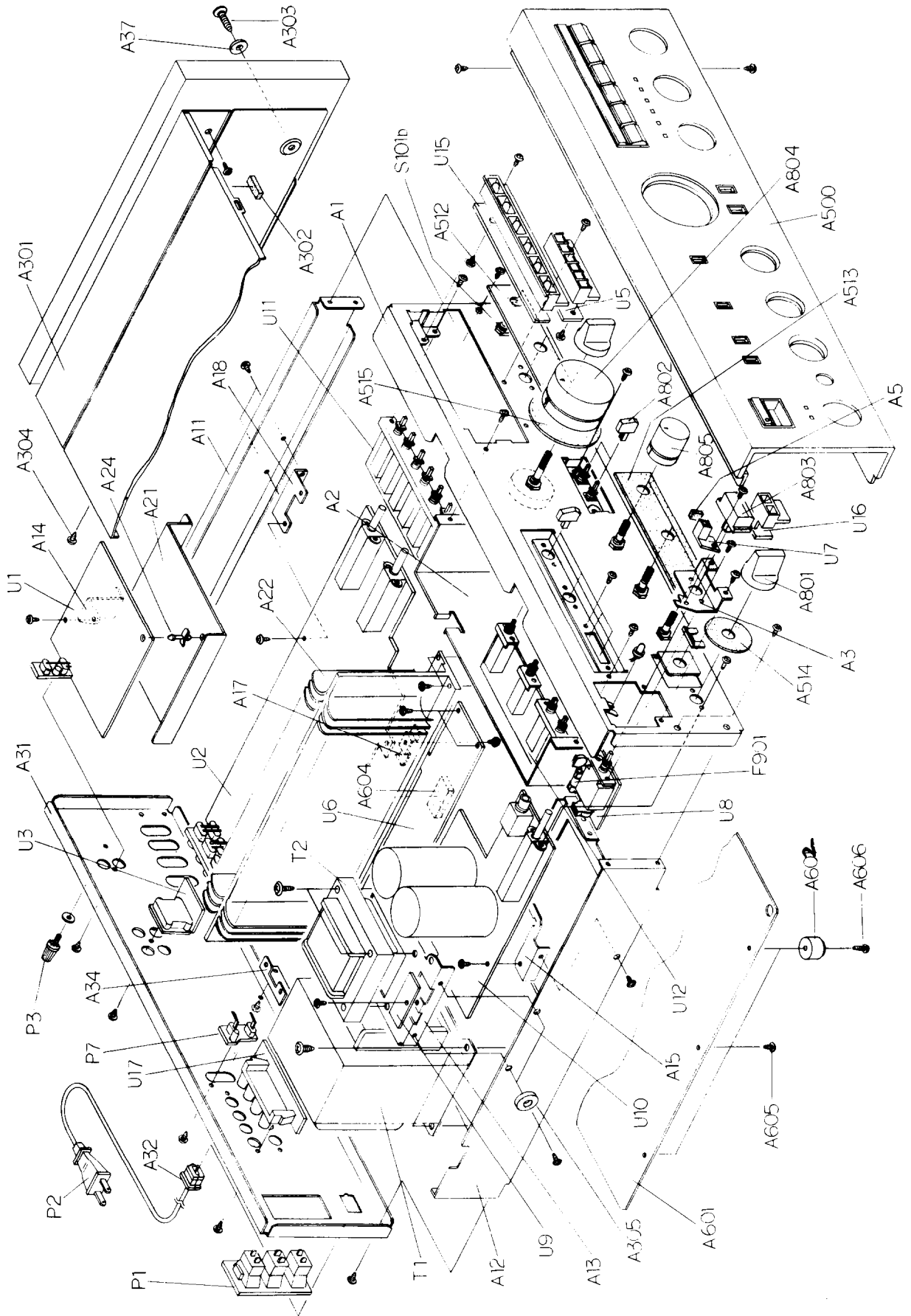

CHASSIS-EXPLODED VIEW-PARTS LIST

REF. NO.	PARTS NO.	DESCRIPTION	REF. NO.	PARTS NO.	DESCRIPTION	REF. NO.	PARTS NO.	DESCRIPTION
A1	27110227E	Front bracket	Q611, Q612	2201523 or 2201524	2SA1186 (O) or 2SA1186 (Y) or 2SA1186 (P), Transistors	U6	17848514-1	NAMA-2514-1, Main pc board ass'y [U] [D] [W]
A2	27130370A	Bracket (Shield)	Q613, Q614	2201525 or 2201533 or 2201534 or 2201535	2SA1186 (Y) or 2SC2837 (O) or 2SC2837 (Y) or 2SC2837 (P), Transistors		17844514-1A	NAMA-2514-1a, Main pc board ass'y [G]
A3	27140944B	Bracket (POW)	Q615, Q616	2201523 or 2201524 or 2201525	2SA1186 (O) or 2SA1186 (Y) or 2SA1186 (P), Transistors	U7	17848513-1	NADIS-2513-1, Servo display pc board ass'y
A5	28140457	Cushion	△ T1	2300045	NPT-856D, Power transformer [U] [D]	U8	17848515-1	NAFU-2515-1, Fuse circuit pc board ass'y [U] [D]
A11	27115132C	Side bracket (R)					17844515-1A	NAFU-2515-1a, Fuse circuit pc board ass'y [G]
A12	27130371C	Bracket (L)					17840515-1B,	NAFU-2515-1b, Fuse circuit pc board ass'y [W]
A13	27130415	Bracket (TP)					17848516-1	NAWT-2516-1, Chock coil pc board ass'y
A14	27140819	Bracket (PC)					17848518-1	NAPS-2518-1, Speaker switch pc board ass'y
A15	27140945	Bracket (K)					17848519-1	NASW-2519-1, Input selector switch pc board ass'y
A17	27140948	Bracket (TR)					17844519-1A	NASW-2519-1a, Input selector [U] [D] [W]
A18	27140693	Bracket (Terminal)					17848520-1	NASW-2520-1, Switch circuit pc board ass'y
A21	27150207	Shield plate (B)					17848521-1	NATC-2521-1, Tone control circuit pc board ass'y
A22	27160181	Radiator					17848522-1	NAV-2522-1, Volume control pc board ass'y
A24	27190011	LCBS-6NS, Holder					17848523-1	NADIS-2523-1, Input display pc board ass'y
A31	27120787A	Back panel [U] [D]	△ T2	2300046	NPT-856G, Power transformer [G]		17848524-1	NADIS-2524-1, Speaker display pc board ass'y
	27120790A	Back panel [G]					17848525-1	NAST-2525-1, Speaker terminal pc board ass'y [U] [D] [W]
	27120791A	Back panel [W]					17844525-1A	NAST-2525-1a, Speaker terminal pc board ass'y [G]
A32	27300750	Back panel					17848526-1	NAST-2526-1, Speaker terminal pc board ass'y [U] [D] [W]
A34	27141040	Bushing (Cable)					17844526-1A	NAST-2526-1a, Speaker terminal pc board ass'y [G]
A37	87644010	Bracket (HT)						
A301	28184304	Top cover [D] [G] [W]	△ P1	25030262	NRS-103-30BU, Cartridge selector, operation section	U9		
	28184310	Top cover [U]						
	28185248	Side board, Right [U]						
	28185249	Side board, Left [U]						
	85143113	M3.1+13F(BC), Wood screw [U]						
A302	87515015	M5-AB, Toothed washer [U]						
A303	28140020	4t x 10 x 40, Cushion						
	838440089	4TTB+8C(BC), Wood screw [U]						
	836440303	4STV+30CQ (BC), Tapping screw [U]						
A304	870086	W4x12 (BC), Washer [U]						
A305	27175011C	3TTS+6B (BC), Tapping screw						
A500	17848121	Cushion						
A512	28140532A	Front panel ass'y						
A513	28140205A	Cushion (Tone)						
A514	28140185	Cushion (Tone)						
A515	28140206B	Cushion						
A601	27170215	Bottom board						
A602	27175044	Bottom leg						
A604	28140265	Cushion						
A605	831430088	3TTW+8B(BC), Tapping screw						
A606	834430168	3TTS+16B(BC), Tapping screw						
A801	28321908	Knob (SP)						
A802	28321909	Knob (PUSH)						
A803	28321905B	Knob (POW)						
A804	28321906A	Knob (VOL)						
A805	28322011	Knob (BAL)						
Q609, Q610	2201533 or 2201534 or 2201535	2SC2837 (O) or 2SC2837 (Y) or 2SC2837 (P), Transistors						

NOTE: [U] : Only U.S.A. model
[D] : Only 120V model
[G] : Only 220V model
[W] : Only 120V/220V model

NOTE: THE COMPONENTS IDENTIFIED BY MARK △ ARE CRITICAL FOR RISK OF FIRE AND ELECTRIC SHOCK. REPLACE ONLY WITH PARTS NUMBER SPECIFIED.

PRINTED CIRCUIT BOARD PARTS LIST

EQUALIZER AMPLIFIER PC BOARD (NAEQ-2154-3/ NAEQ-2154-3a) PARTS LIST

CIRCUIT NO.	PART NO.	DESCRIPTION
	ICs	
Q105, Q106	222570	NJM4560DX
	Transistors	
Q101 ~ 104	2211783 or 2211782	2SA991 (E) or 2SA991 (F)
	Diodes	
D101 ~ D104	223145	1S2076TD
	Capacitors	
C101	379122234	0.022 μ F, 50V, Film (DEW)
C101	379121035	0.01 μ F, 50V, Film (DEW) [G]
C103, C104	372121014	100pF, 50V, Styrene [G]
C105, C106	372122204	22pF, 50V, Styrene [G]
C107, C108	379128225	0.0082 μ F, 50V, Film (DEW)[G]
C109, C110	379128225	0.0082 μ F, 50V, Film (DEW)[G]
C111, C112	392841007	10 μ F, 16V, Elect. (LL)
C115, C116	372122214	220pF, 50V, Styrene
C119, C120	379124725	0.0047 μ F, 50V, Film (DEW)
C121, C122	379122234	0.022 μ F, 50V, Film (DEW)
C123, C124	379121834	0.018 μ F, 50V, Film (DEW)
C125, C126	379124734	0.047 μ F, 50V, Film (DEW)
C127, C128	3500084	2200 μ F, 6.3V, Elect.
C129, C130	392880227	2.2 μ F, 50V, Elect. (LL)
C131, C132	379121225	0.0012 μ F, 50V, Film (DEW)
C141, C142	352752219	220 μ F, 25V, Elect.
	Coils	
L101, L102	231030	NCH-1070, Coil [G]
	Switch	
S101a	25065229	NSS-63100, Remote switch
	Terminal	
	25045182	NPJ-2PDBL72, Input terminal

POWER AMPLIFIER PC BOARD (NADA-2507-1/ NADA-2507-1a) PARTS LIST

CIRCUIT NO.	PART NO.	DESCRIPTION
	ICs	
Q519, Q520	222502	NJM4558DX
	Transistors	
Q501, Q502	2212805 or 2212806 or 2212807	2SK389 (GR) or 2SK389 (BL) or 2SK389 (V)
Q503 ~ Q506	2211733 or 2211732	2SC1845 (E) or 2SC1845 (F)
Q507, Q508	2211515 or 2211516	2SA995 (F) or 2SA995 (G)
Q511, Q512	2211455 or 2210803	2SA1015 (GR) or 2SA733 (P)
Q513, Q514	2211354 or 2211353	2SA949 (Y) or 2SA949 (O)
Q515, Q516	2211634 or 2211633	2SC2229 (Y) or 2SC2229 (O)
Q517, Q518	2211255	2SC1815 (GR)
Q901	2201512 or 2201513	2SD1200 (Q) or 2SD1200 (R)
Q902	2201502 or 2201503	2SB889 (Q) or 2SB889 (R)

	Diodes	
D501 ~ D504	223145	1S2076TD
D505, D506	225126	GL-3PR1, LED
D507 ~ D510	223145	1S2076TD
D511, D512	225126	GL-3PR1, LED
D513, D514	223145	1S2076TD
D515, D516	4000068	VD1222, Varistor
D517 ~ D520	223145	1S2076TD
D901, D902	2239754 or 2243294	RD22E-B4 or MTZ22-D
	Capacitors	
C305 ~ C312	372121014	100pF, 50V, Styrene [G]
C501, C502	372126804	68pF, 50V, Styrene
C503, C504	372121014	100pF, 50V, Styrene
C505, C506	379121235	0.012 μ F, 50V, Film (DEW)
C509, C510	379122235	0.022 μ F, 50V, Film (DEW)
C511, C512	372123304	33pF, 50V, Styrene
C513 ~ C516	352752209	22 μ F, 25V, Elect.
C519, C520	379123935	0.039 μ F, 50V, Film (DEW)
C901, C902	352772219	220 μ F, 50V, Elect.
C903, C904	352754709	47 μ F, 25V, Elect.
C905, C906	3500086	470 μ F, 25V, Elect.
	Resistors	
R523, R524	442520684	6.8 Ω , 1/2W, Metal oxide film
R525, R526	442525614	560 Ω , 1/2W, Metal oxide film
R527, R528	442524734	47k Ω , 1/2W, Metal oxide film
R531, R532	5225072	N10HR4.7KBDM, Semi-fixed
R533, R534	442524724	4.7k Ω , 1/2W, Metal oxide film
R549, R550	442520474	4.7 Ω , 1/2W, Metal oxide film
R901, R902	441525114	510 Ω , 1/2W, Metal oxide film
R958	442527514	750 Ω , 1/2W, Metal oxide film
	Switches	
S302	25030195	NRSM-146-30SS
S303	25030258	NRSM-166-30SS
	Terminal	
	25045137	NPJ-6PDBL52, Input terminal

CD/TUNER INPUT TERMINAL PC BOARD (NAPJ-2510-1/NAPJ-2510-1a) PARTS LIST

CIRCUIT NO.	PART NO.	DESCRIPTION
	Capacitors	
C301 ~ C304	372121014	100pF, 50V, Styrene [G]
	Terminal	
	25045171	NPJ-4PDBL65, Input terminal

AUX/MODE SWITCH PC BOARD (NASW-2511-1) PARTS LIST

CIRCUIT NO.	PART NO.	DESCRIPTION
	Switches	
S301, (S305)	25035301	NPS-222-L249
	Socket	
JC311	25050270	NSCT-6P98

REC. DISPLAY PC BOARD (NADIS-2509-1) PARTS LIST

CIRCUIT NO.	PART NO.	DESCRIPTION
	Diodes	
D321 ~ D326	225167RB or 225167RC	GL-5HY10-RB, LED or GL-5HY10-RC, LED
	Holder	
	27190317	Holder, LED (6)

**MAIN AMPLIFIER PC BOARD (NAMA-2514-1/
NAMA-2514-1a) PARTS LIST**

CIRCUIT NO	PART NO.	DESCRIPTON
	IC	
Q701	222584	TA7317P
	Transistors	
Q601, Q602	2211634 or 2211633	2SC2229 (Y) or 2SC2229 (O)
Q603, Q604	2211354 or 2211353	2SA949 (Y) or 2SA949 (O)
Q605, Q606	2201644 or 2201643	2SC3298 (Y) or 2SC3298 (O)
Q607, Q608	2201634 or 2201633	2SA1306 (Y) or 2SA1306 (O)
Q617, Q618	2211733 or 2211732	2SC1845 (E) or 2SC1845 (F)
	Diodes	
D701	223862	WL-01
D702, D704	223145	1S2076TD
D703	2239492 or 2243162 or 2239493 or 2243163	RD6.2E-B2 or MTZ6.2-B or RD6.2E-B3 or MTZ6.2-C
	Coils	
L601, L602	231015	S-0.8C
L603, L604	230904	B-20L44 FR Coar [G]
	Capacitors	
C605, C606	379121045	0.1 μ F, 50V, Film (DEW)
C607, C608	379124735	0.047 μ F, 50V, Film (DEW)
C611~C614	379121045	0.1 μ F, 50V, Film (DEW)
C701	352722219	220 μ F, 6.3V, Elect
C703	352732209	22 μ F, 10V, Elect
C704	352784799	0.47 μ F, 50V, Elect.
C706	352743319	330 μ F, 16V, Elect.
C707	352744719	470 μ F, 16V, Elect.
C708	379122237	0.022 μ F, 50V, Film (DEW)
C710	379122235	0.022 μ F, 50V, Film (DEW)
	Resistors	
R601, C602	442521024	1k Ω , 1/2W, Metal oxide film
R603, R604	442521014	100 Ω , 1/2W, Metal oxide film
R605~R612	442520224	2.2 Ω , 1/2W, Metal oxide film
R613~R616	4000063	0.47 Ω , 2W, Metal oxide film
R617, R618	441620104	1 Ω , 1W, Metal oxide film
R619~R622	4000063	0.47 Ω , 2W, Metal plate
R623, R624	441620104	1 Ω , 1W, Metal oxide film
R629~R632	4000061	0.33 Ω , 2W, Metal plate
R639~R642	441621604	16 Ω , 1W, Metal oxide film
R713	442523304	33 Ω , 1/2W, Metal oxide film
	Lamp	
PL701	210183	PL14V 0.06A W-2.0
	Relay	
RL701	25065036	NRL-4P3A-DC12-01
	Sockets	
JC705, JC709	25050267	NSCT-3P95
JC706	25050272	NSCT-8P100
	Fuse holder	
	25050065	YSH503T [G]

**SERVO DISPLAY PC BOARD (NADIS-2513-1)
PARTS LIST**

CIRCUIT NO.	PART NO.	DESCRIPTION
	Diodes	
D711	225174 or 225173	SLR55MC3N or SLR55MC3M, LED
	Holder	
	27190319	Holder, LED (1)

**FUSE CIRCUIT PC BOARD (NAFU-2515-1/
NAFU-2515-1a/NAFU-2515-1b) PART LIST**

CIRCUIT NO.	PART NO.	DESCRIPTON
C911, C912	3500065A	0.01 μ F, AC400/125V, Capacitor IS
S911	25035381	NPS-121-L345P, Switch [D]
S911	25035015A	NPS-111LA3, Switch [G] [W]
F901a	250113	S-N5051, Fuse holder
	29360486	7A/125V, Fuse lable
F901a	25050065	YSH403T, Fuse holder [G]
P911, P912	27300601	SB-1925, Cover, capacitor

**SPEAKER SWITCH PC BOARD (NAPS-2518-1)
PARTS LIST**

CIRCUIT NO.	PART NO.	DESCRIPTION
	Diodes	
D951	223898F	RB602
D952, D953	223845F	GP-20DL
	Capacitors	
C951~C953	375104745	0.47 μ F, 125V, Film (ME)
C954, C955	3504176	20000 μ F, 69V, Elect.
	Resistors	
R753, R754	441623914F	390 Ω , 1W, Metal oxide film
R951	442525104F	51 Ω , 1/2W, Metal oxide film
R964, R965	441522294F	0.22 Ω , 1/2W, Metal oxide film
	Switch	
S751	25030257	NRSM-164-30SS
	Jack	
	25045164	HLJ4317-01-3020, Stereo
	Bass plate	
	27300731	Bass (C)
	27300732	Bass (P)

**INPUT SELECTOR SWITCH PC BOARD
(NASW-2519-1/NASW-2519-1a) PARTS LIST**

CIRCUIT NO.	PART NO.	DESCRIPTON
	Capacitors	
C313, C314	372122214	220pF, 50V, Styrene [G]
	Switches	
S304	25035507	NPS-642-L469
	Sockets	
JC303C~JC305	25050273	NSCT-9P101

**SWITCH CIRCUIT PC BOARD (NASW-2520-1)
PARTS LIST**

CIRCUIT NO.	PART NO.	DESCRIPTION
	Capacitors	
C315, C316	352781599	0.15 μ F, 50V, Elect.
	Switches	
S306, S308	25035266	NPS-122-1230
S307, S701	25035269	NPS-222-L233
	Plate	
	27150208	Shield plate

**TONE CONTROL CIRCUIT PC BOARD (NATC-2521-1)
PARTS LIST**

CIRCUIT NO.	PART NO.	DESCRIPTION
Capacitors		
C317, C318	379121235	0.012 μ F, 50V, Film (DEW)
C319, C320	379125625	0.0056 μ F, 50V, Film (DEW)
C321, C322	379121025	0.001 μ F, 50V, Film (DEW)
C323, C324	379123335	0.033 μ F, 50V, Film (DEW)
C325, C326	372125614	560pF, 50V, Styrene
Resistors		
R323	5148044	N16RGMC250KMN30
R327	5148046A	N16RGM11C219K30
R329	5148045A	N16RQM11C110K180K30

**VOLUME CONTROLE PC BOARD (NAVR-2522-1)
PARTS LIST**

CIRCUIT NO.	PART NO.	DESCRIPTION
Resistor		
R351	5172062	N24RGL100KBTP30

**INPUT DISPLAY PC BOARD (NADIS-2523-1)
PART LIST**

CIRCUIT NO.	PART NO.	DESCRIPTION
Diodes		
D301 ~ D306	225174 or 225173	SLR55MC3N, LED or SLR55MC3M, LED
Holder		
	27190316A	Holder LED (12)

**SPEAKER DISPLAY PC BOARD (NADIS-2524-1)
PARTS LIST**

CIRCUIT NO.	PART NO.	DESCRIPTION
Diodes		
D751, D752	225174 or 225173	SLR55MC3N, LED or SLR55MC3N, LED
Holder		
	27190318	Holder LED (2)

**SPEAKER TERMINAL PC BOARD (NAST-2525-1/
NAST-2525-1a) PARTS LIST**

CIRCUIT NO.	PART NO.	DESCRIPTION
Capacitors		
C751, C752	379121025	0.001 μ F, 50V, Film (DEW) [G]
Terminal		
	25060098	NTM-4PDMN38, Speaker terminal

**SPEAKER TERMINAL PC BOARD (NAST-2526-1/
NAST-2526-1a)**

CIRCUIT NO.	PART NO.	DESCRIPTION
Capacitors		
C753, C754	379121025	0.001 μ F, 50V, Film (DEW) [G]
Terminal		
	25060098	NTM-4PDMN38, Speaker terminal

NOTE

[D] : Only 120V model
 [G] : Only 220V model
 [W] : Only 120V/220V model

PACKING PROCEDURES

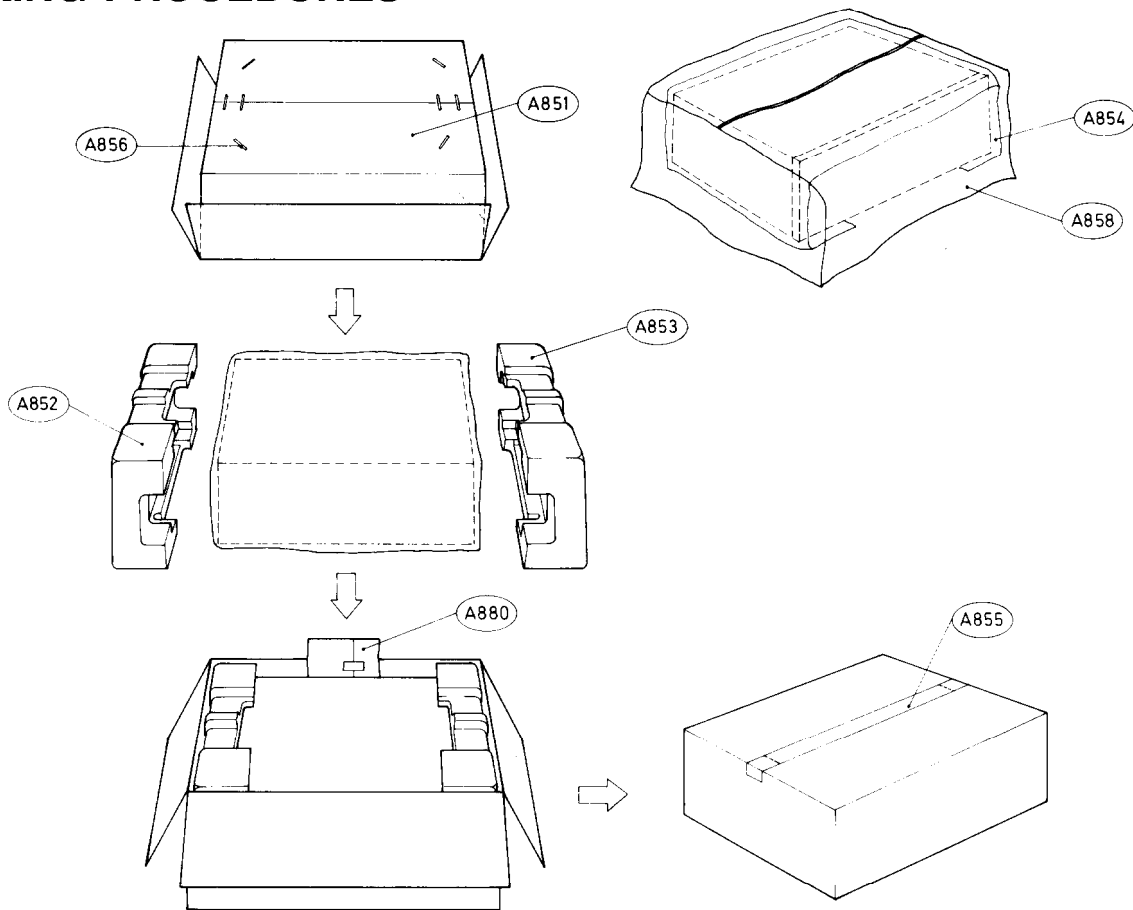

REF. NO.	PART NO.	DESCRIPTION	
A851	29051236	Master carton box	[D] [G] [W]
	29051239	Master carton box	[U]
A852	29091053A	Pad, left	[D] [G] [W]
	29090830A	Pad, left	[U]
A853	29090489B	Pad, right	[D] [G] [W]
	29090831A	Pad, right	[U]
A854	29095012-1	800 x 500, Protection sheet	[D] [G] [W]
	29095319	1000 x 500, Protection sheet	[U]
A855	260012	Damplon tape	
A856	282301	Sealing hook	
A858	29100038A	729 x 950, Poly bag	
A859	29091071	Pad, ass'y, bottom	[U]
A880	Accessory bag ass'y		
	29340960	Instruction manual	[D] [U]
	29340961	Instruction manual	[G] [W]
	29365006-7	Warranty card	[U]
	29358002C	Service station list	[U]
	29100006A	350 x 250, Poly bag	
	25055018	CV-K-1, Conversion plug	[W]

NOTE: [U] : Only U.S.A. model
 [D] : Only 120V model
 [G] : Only 220V model
 [W] : Only 120V/220V model

ONKYO CORPORATION

International Division: No. 24 Mori Bldg., 23-5, 3-chome, Nshi-Sinbashi, Minato-ku, Tokyo, Japan
 Telex: 2423551 ONKYO J. Tel. 03-432-6981

ONKYO U.S.A. CORPORATION

200 Williams Drive, Ramsey, N.J. 07446 Telex: 25-710-988-1033 Tel. 201-825-7950